

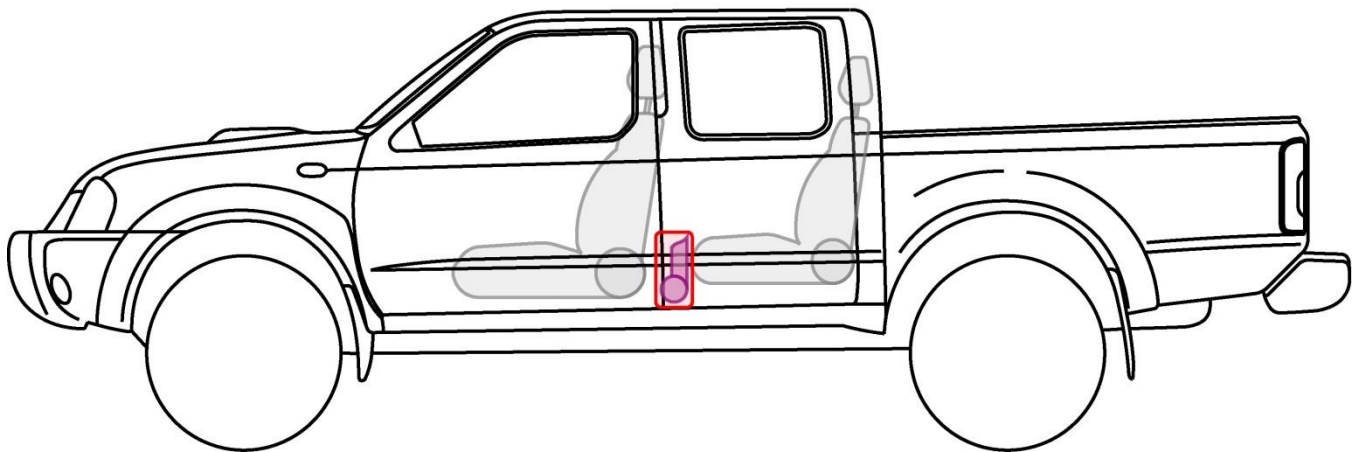

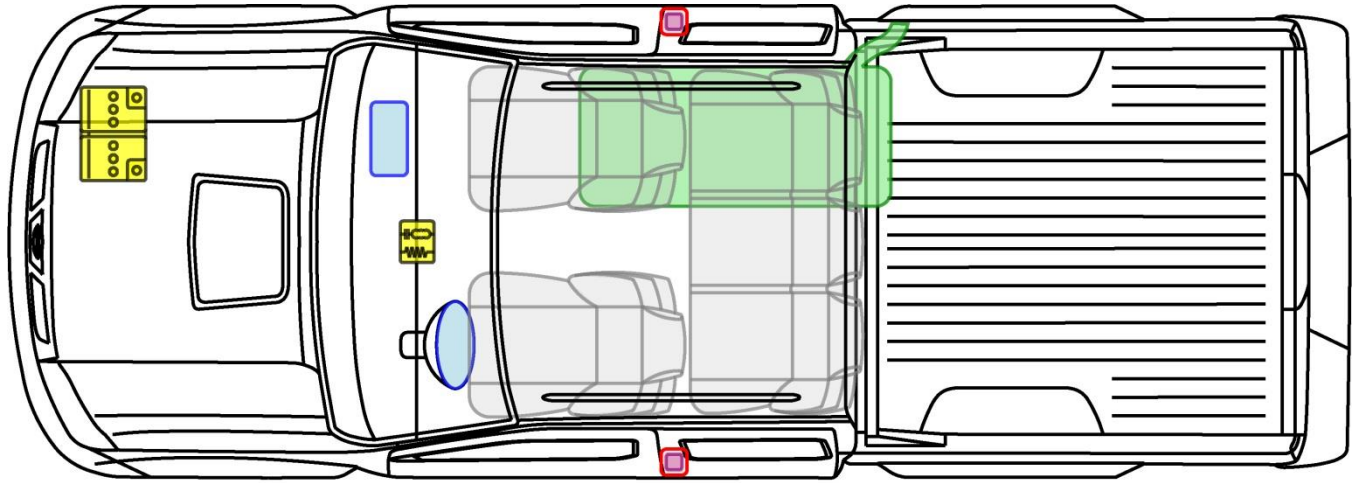



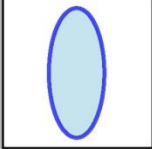

# NP300 Double Cab

Typ: D22, 2008-2011

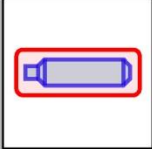

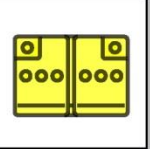
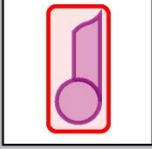
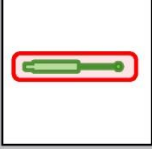
## Legende

	Airbag		Karosserie- verstärkung		Steuergerät
	Gas- generator		Überroll- schutz		Batterie
	Gurt- straffer		Gasdruck- dämpfer		Kraftstoff- tank

NP300